















ΤΖΑΚΙ - FIREPLACE ΑΕΡΟ ΤΡΙΠΛΕΥΡΟ

Τεχνικά Χαρακτηριστικά | Technical Characteristics

	<b>Εσωτερικές Διαστάσεις (πλάτος x Βάθος x Ύψος)   Internal Dimensions (Width x Depth x Height)</b>	<b>80 x 41 x 36 cm</b>
	<b>Εξωτερικές Διαστάσεις (πλάτος x Βάθος x Ύψος)   External Dimensions (Width x Depth x Height)</b>	<b>92.4 x 60 x 134 cm</b>
	<b>Απόδοση   Efficiency</b>	<b>70 %</b>
	<b>Όγκος Θέρμανσης   Capacity</b>	<b>120 - 270 m<sup>3</sup></b>
	<b>Ισχύς   Power</b>	<b>4 - 15 kw</b>
	<b>Κατανάλωση Ξύλου   Wood Consumption</b>	<b>3.5 kg/h</b>
	<b>Βεντιλατέρ   Ventilator</b>	<b>-</b>
	<b>Ενεργειακή κλάση   Energy Class</b>	<b>A</b>
	<b>Διαστάσεις Τζαμιού (πλάτος x Ύψος)   Glass Dimensions (Width x Height)</b>	<b>91 x 35 cm &amp; 42 x 35 cm</b>
	<b>Διατομή καμινάδας   Smoke Outlet</b>	<b>Ø 25</b>
	<b>Βάρος με βερμικουλίτη   Weight in Vermiculite</b>	<b>222 kg</b>
	<b>Βάρος με μαντέμι   Weight in Cast-iron</b>	<b>258 kg</b>

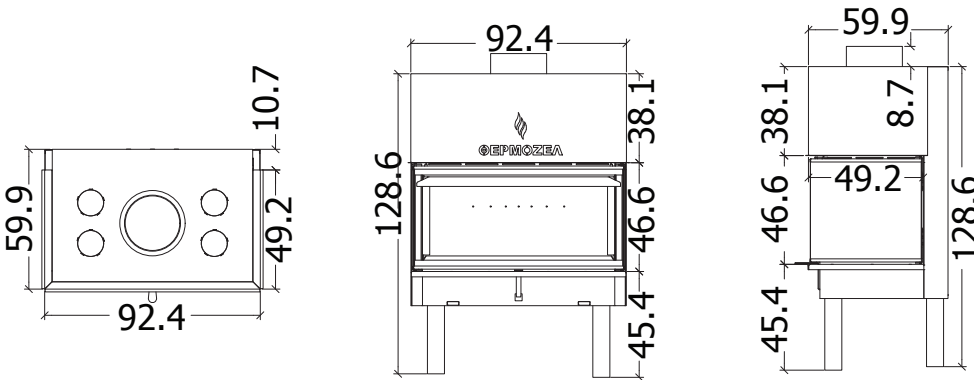

P: +30 26340 45376  
E: sales@thermozel.gr  
W: www.thermozel.gr

**THERMOZEL SA**

Σκανάρετε για να επισκεψείτε την ιστοσελίδα μας | Scan to visit our website